

DC Shocker Controller

PDC-2x series

User Manual

SUPERTECH Instruments

General Description

DC Shocker Controller PDC-2x is a programmable pulse pattern generator. It is based on a RISC microcontroller. The built-in firmware generates the different output pulse sequences. The firmware of this equipment is the same as of the Pulse Pattern Generator of the BioStim Controller.

DC Shocker Controller PDC-2x is manufactured in two versions:

A) Modular version: as a part of the Modular Behavioral System. This version has no its own power supply. This version is powered by the Power Supply Module MBPS-3 of the Modular Behavioral System. You should ask Supertech Instruments if you need the User Manual of the modular version of DC Shocker Controller PDC-2x.

B) Stand alone version. This equipment contains a built-in mains power supply. This version of the DC Shocker Controller can be used as a stand alone equipment, connected to and controlled by any data acquisition system. It can control any external animal shocker equipment (which has TTL control input). This User Manual has been written to describe the stand alone version of DC Shocker Controller PDC-2x.

The accuracy of the time parameters in the DC Shocker Controller is guaranteed by an internal crystal pacer. All the programmed time parameters are stored in a built-in nonvolatile memory. Easy programming operations are carried out in menu system with a 4-button keypad. The display of the DC Shocker Controller is a 4 x 20 character alphanumeric model with blue backlight to provide good visibility.

The time parameters are provided by the fully digital DC Shocker Controller and the constant current sources are implemented in the Shocker equipments. This arrangement results a great flexibility and variability, because all shocker models manufactured by Supertech Instruments are compatible with the DC Shocker Controller, so they can be changed according to the experimental paradigm.

With one DC Shocker Controller equipment you can even control several shockers simultaneously.

Accessories

DC Shocker Controller PDC-2x can be used together with any shocker model manufactured by Supertech Instruments. Certainly, the shocker equipments should be ordered independently. They are functional, but not free accessories of the DC Shocker Controller PDC-2x.

Mains cable, compatible with the selected mains voltage and wall socket.

Security Rules

DC Shocker Controller PDC-2x alone is not dangerous equipment. But it is always connected to one (or more) of the shockers. The shockers are constant current generators, operating on very high compliance voltages. Furthermore the shocking grids are big, free and can be touched by hand. The maximal output current of the DC Shocker is more than enough to force the human heart to stop. Be extremely careful if you use these equipments.

IMPORTANT! Please read through the Security Rules section in the User Manual of the DC Shocker, too.

Specifications

Inputs: TTL compatible, 0.5 unit-loads

Outputs: TTL compatible, 10 unit-loads

Input signals:

- Start Input
- Gate Input

Output signals:

- Synchron Output
- TTL Output (to Shocker)

Number (choice) of predefined pulse patterns in the main menu: 12

Accuracy of the time parameters: 10 ns

First Time Installation and Setup

Please connect all the cables:

- Mains cable to the power point (wall socket)
- TTL output cable(s) to the Shocker(s)
- Optional control cables from the PC-based data acquisition system

After finishing the cabling switch on the DC Shocker Controller PDC-2x and it is ready to operate.

Functions in the Firmware

DC Shocker Controller PDC-2x (together with one of the Shockers) can be used as a stand alone pulse pattern generator, but it has bi-directional digital control capabilities: Start Input, Gate Input, and Synchron Output. These TTL-compatible

control bits offer a huge versatility in the different applications. DC Shocker Controller PDC-2x can be started externally (with rising edge at Start Input) from another equipment (for instance a PC), or it can be the master synchron generator (if the external equipments are triggered from its Synchron Output).

DC Shocker Controller PDC-2x has a nonvolatile memory to store all parameters of the functions. The memory holds the previously used parameter values during switched off periods. If you use the equipment in a fixed application, you should program it one time only. If you switch the DC Shocker Controller PDC-2x on, it checks, which function was used last time. After it the parameters used by the actual function are checked. If the parameters have valid values preset, the last used function will be started automatically.

Programming Conventions and Definition of Terms in the Firmware

The functions are categorized in two groups. The first group contains the 'single' functions. 'Single' functions are initiated by the START event. After a START event they generate their sequence one time only (an example is Single Burst). The other category is the group of the 'repetitive' functions. They repeat their sequence periodically (an example is Continual Bursts).

A subcategory of the 'single' functions is the group of the 'delayed' functions. They are the same as their appropriate 'single' equivalents, but a programmable delay is occurring at the beginning of the sequence before the first Output pulse.

START event means a key press on START button, or a TTL rising edge appearing on Start input. The two source of Start event can be used together or independently any time (they are in logical OR relation).

You can clear all stored parameters if you press and hold F button down, while DC Shocker Controller PDC-2x is switched on.

Operating Modes of the DC Shocker Controller PDC-2x

The actually realized 12 operating modes (in other words the choice of the pulse patterns) are presented in the end of this User Manual. The operating modes have got a graphical interpretation to explain them in fine details. In some experimental situations there is more than one function with which a paradigm can be carried out. You should always consider which function is the best one to your special task.

Emergency Stop

If you experience any unwanted effect (such as electric shock, unexpected parasite stimulating effect in the living tissue, coagulation, burn, etc.) during the output pulse sequence, you can stop the actual action of the DC Shocker Controller PDC-2x by

pressing the F button. After making an emergency stop, please switch off the DC Shocker Controller and the Shocker, investigate the circumstances and repair the fault before continuing the work.

Certainly, simple switching off the Shocker will also cancel its activity. But because of the huge energy buffer of its power supply, the real shutting down after switching off is delayed. Switching off is slower than the Emergency Stop process.

Error Messages

During programming actions the equipment checks the validity of the actually entered parameter value. If you try to accept (with F button) a parameter out of the range, the firmware will not allow it. If the selected parameters are valid each by each, but more than one parameter is incoherent together, you will be asked by the firmware to correct them.

Front Panel Controls

DC Shocker Controller PDC-2x is assembled with a 4 x 20 character blue LCD display and a user-friendly 4-button keypad on its front plate. The development strategy of this equipment was to design an easy-to-use user interface, while highly professional capabilities are activated behind the simple menu system.

Next to the LCD display there are four pushbuttons. With them you can do all what you would like to do.

F (Function) button: It has got two functions according to the actual situation. Use it in the menu as Enter during the programming and parameter setup actions. When you are in a programming phase and the Function button works as Enter, the microcontroller automatically saves the newly selected value (if the numeric parameter is valid) after F key was pressed. When the equipment is actually working in a selected function, the F button can be used as Escape to inactivate the function (leave the actual task) and to jump to the Function Choice menu.

UP and DOWN buttons: Use them to navigate in menus (to choose from the menu items) and modify the parameter values up or down, respectively. Where you see the cursor you can adjust the appropriate menu point or you can set that numeric value what is under the cursor.

START button: It is used to start the sequence of pulses, if a 'single' or a 'delayed' function is selected actually. The 'repetitive' functions can be interrupted temporarily with START button (and they can be restarted again with it).

Active LED shows the working (pulsing) actions of the DC Shocker Controller.

Connectors and Controls on the Back Side

Socket for the mains cable

Start Input: TTL rising edge appearing at this input means an external start signal for the microcontroller. This signal is in logical OR relation with the Start button on the front plate.

Gate Input: it is used in the Gated Continual function. TTL L level at this input disables the output pulse sequence. If you do not connect anything to this input, an internal pull-up resistor provides H level internally. In other words pulsing in the Gated Continual function is enabled by default.

Synchron Output: the 'Single' and 'Delayed' functions generate a TTL H level pulse at the beginning of the sequence of pulses at this output. This signal can be used as start signal for an external data acquisition system if the DC Shocker Controller operates as the master signal timing generator.

These TTL-compatible control bits offer a huge versatility in the different data acquisition and experiment control applications. The exact functions and effects of the above listed control signals are explained in the graphical demonstration of the pulse patterns in the end of this User Manual.

TTL Output: pulse pattern output for the shocker(s). From the TTL Output you can control more than one shocker. You should simply connect the TTL control inputs of your shockers with BNC T-junctions.

Calibration

DC Shocker Controller PDC-2x is fully digital equipment, powered by a fast RISC microcontroller and with functions written in the built-in firmware. That is, why calibration is neither necessary, not possible. However if you want to check the accuracy of the pulse patterns, you can do it with a fast and precise digital storage oscilloscope.

Warranty

Supertech Instruments gives you 5 years of full warranty for electronic products and 3 years of full warranty for mechanical products by default. Longer warranty periods can also be defined and agreed (the actual conditions should be discussed before placing the order).

Supertech Instruments gives you full warranty for its products against defects in materials or workmanship as long as the equipment has been subjected to normal and proper use. During the warranty period, faulty products will be repaired or replaced free of charge provided they are returned to our workshop. Postage of the warranty

repair actions is paid by the Customer. The exceptions are the Vibration Isolation Tables. There are special conditions introduced for repairing of Vibration Isolation Tables (see the appropriate User Manual). Supertech Instruments will undertake the servicing and calibration after the expiration of the warranty period for a nominal fee.

The warranty does not cover the faults made by the user.

The measuring equipments manufactured by Supertech Instruments are for experimental and/or lab animal purposes only and are not intended for human use.

Electrical safety measurements of proper operation of the 115 / 230 V AC mains electric system (from the equipments have been supplied) is the sole responsibility of the user.

You can find the general commercial and warranty conditions in the beginning of the Services page of our website.

Further Information Sources

As the first step for further technical information please visit our website(s). On the website of Supertech Instruments you can find related products and further information.

On the Download page of our website you can find many more useful documents to support our products. Please check the list of the available documents.

Technical hotline via email (all of them work):

office@superte.ch

office@supertechinstruments.co.uk

office@super-tech.eu

International technical hotline on the phone: +36 20 923 4386

Supertech Instruments continuously uses several domain names (websites) with the same content. Please use that one, which is the easiest for you to remember:

www.superte.ch

www.supertechinstruments.co.uk

www.supertech-instruments.co.uk

www.supertech-instruments.com

www.super-tech.eu

DC via Control

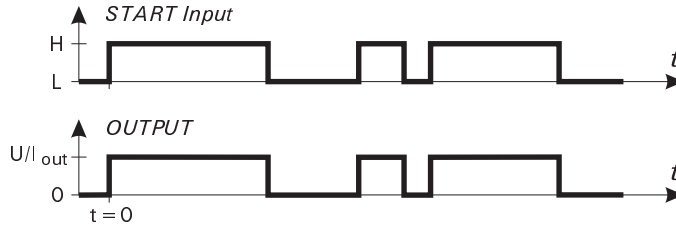

Output is active, while START button is pressed, or TTL high level is applied to START Input. This mode offers free control capability from any other equipment (e.g. another stimulator controller, or a TTL port bit of a computer).

DC by Long-Timer

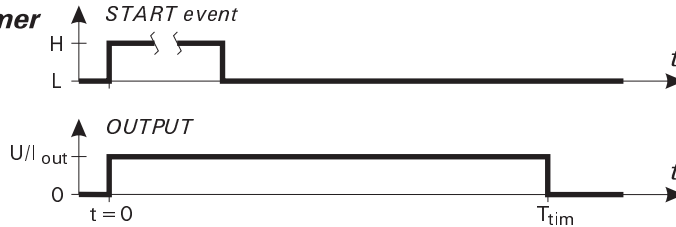

Output is active (constant DC level adjustable by the helical potmeter on the End-stage) in a programmed period, in the range of 10 - 600 sec, with 10 sec of resolution. This period starts at the beginning of the START event.

Wide Pulse/Pause

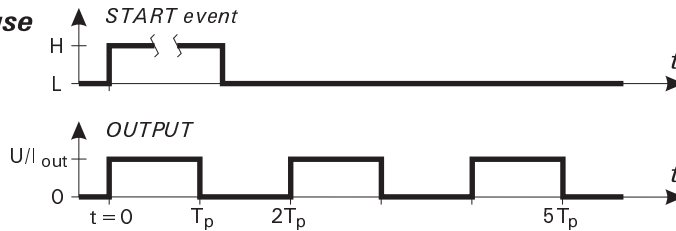

Wide pulses, and pauses (they are equal in width) are generated. The duration of the pulses (and the pauses) can be programmed from 10 - 990 milliseconds, in 10 ms steps.

Delayed Pulse & Single Pulse

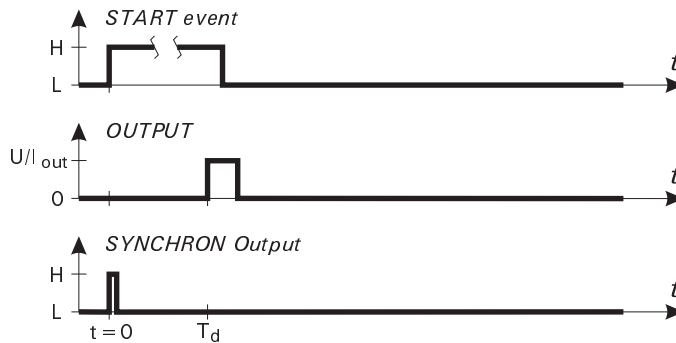

A delay (1 - 250 milliseconds in width, with 1 ms of resolution) is occurring after START event. Just after the delay time an Output pulse is generated (0.1 - 9.9 milliseconds in width, with 0.1 ms of resolution). A Synchron pulse (50 μs) is generated at the START event (at the beginning of the delay time period). Single Pulse function is a special case of Delayed Pulse function, when delay time equals to zero.

Delayed Burst & Single Burst

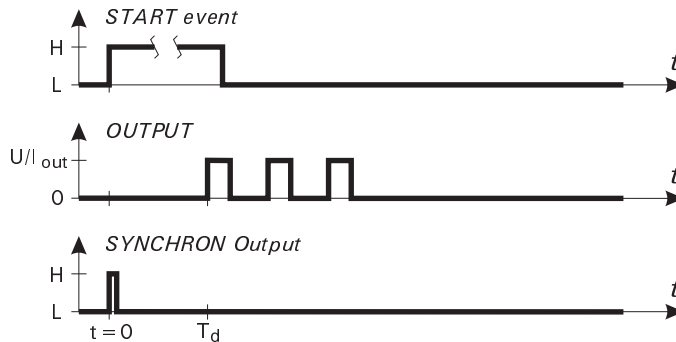

A delay (1 - 250 milliseconds in width, with 1 ms of resolution) is occurring after START event. Just after the delay time a programmed number (2 - 99 pieces) of pulses are generated. The width of the pulses, and the pauses between the pulses can be set in the range of 0.1 - 9.9 milliseconds, with 0.1 ms of resolution. A Synchron pulse (50 μs) is generated at the START event (once at the beginning of the delay time period, in every bursts). Single Burst function is a special case of Delayed Burst function, when delay time equals to zero.

Continual Bursts

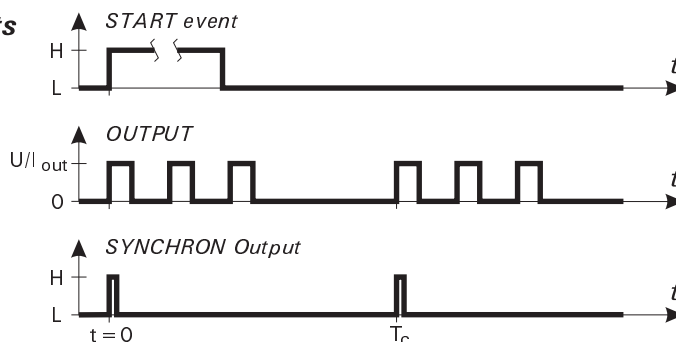

Repetitive bursts of pulses (2 - 99 pulses/cycle) are generated on the Output. The time parameters of the components in the bursts are the same as in the Single Burst, and the Delayed Burst functions. The repetition cycle time (Tc) can be set from 10 ms - 60 sec, with 10 ms of resolution. A Synchron pulse is generated at the rising edge of the first Output pulse (once at the beginning in every bursts).

Gated Continual & Continual Pulses

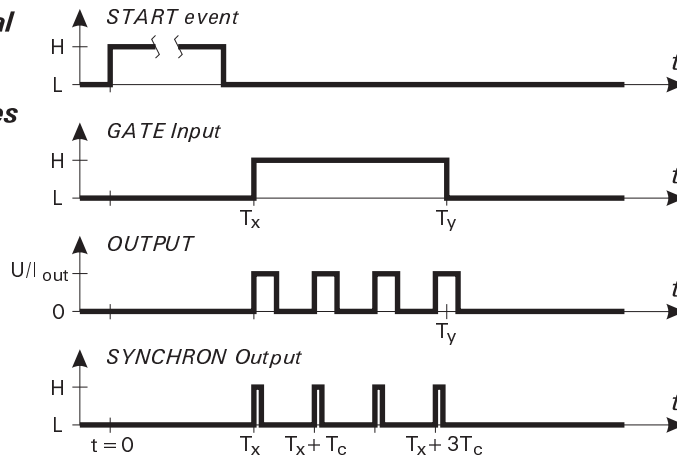

Repetitive pulses (0.1 - 9.9 milliseconds in duration, with 0.1 ms of resolution) are generated on Output. The repetition cycle time (T_c) can be set from 10 ms - 60 sec, in 10 ms steps. Synchron pulses are generated at the beginning of every Output pulses. The flow of Output pulses are disabled if TTL low level is applied to the Gate input. The pulses are never broken, because an asynchronous Gate signal is synchronised internally. Remotely controlled bursts can be realised in this function using another stimulator controller, or a computer. Continual Pulses function is a special case of Gated Continual function, when BioStim Controller ignores the Gate signal, resulting continuous flow of pulses, beginning at START event.

Flexible Burst

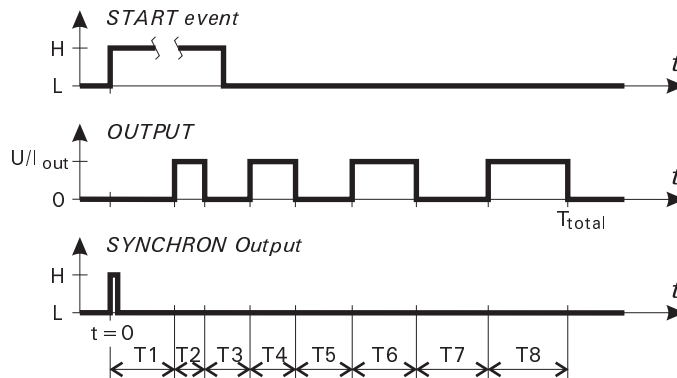

A freely defined burst of pulses can be composed in this function. The number of pulses in the burst can be set from 2 to 10. The length of the pauses, and the durations of the pulses can be set independently from each other. The pauses can be programmed from 0.1 ms to 500.0 ms, with 0.1 ms of resolution. The width of pulses can be programmed from 0.1 ms to 25.0 ms, with 0.1 ms of resolution. A Synchron pulse (50 μ s) is generated at START event at the beginning of the first pause (in other words at the beginning of delay time period).

Variable Pulse

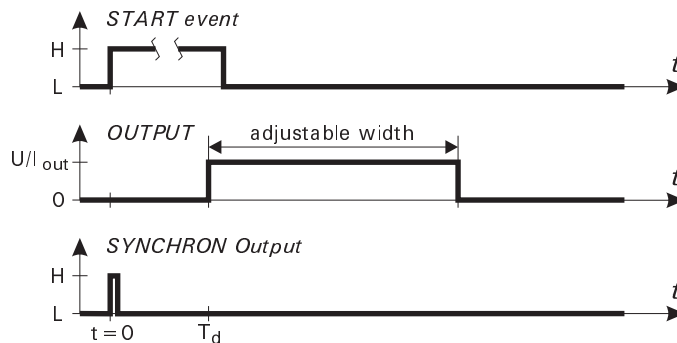

A delay (1 - 250 milliseconds in width, with 1 ms of resolution) is occurring after START event. A Synchron pulse is generated at the beginning of delay time period. Just after the delay time an Output pulse is appearing. The duration of the Output pulse can be set from 10 μ s to 20.0 ms, with very fine, 10 μ s of resolution. The width of the Output pulse can be modified on-the-fly. If you modify the pulse width, the actual pulse will be finished with the last duration, but the next one will be produced with the new duration (at the next START event).

Programming conventions, and definition of terms

BioStim Controller has got a nonvolatile memory to store all parameters of the functions. If you use the equipment in a fixed application, you should program it one time only. If you switch the BioStim Controller on, it checks, which function was used last time. After it the parameters used by the actual function are checked. If the parameters have got valid values preset, the last used function will be started automatically.

The functions are categorized in two groups. The first group contains the 'single' functions. 'Single' functions are initiated by the START event. After a START event they generate their sequence one time only (an example is Single Burst). The other category is the group of the 'repetitive' functions. They repeat their sequence periodically based on an internal crystal pacer (an example is Continual Bursts).

A subcategory of the 'single' functions is the group of the 'delayed' functions. They are the same as their appropriate 'single' equivalents, but a programmable delay is occurring at the beginning of the sequence before the first Output pulse.

START event means a keypress on START button, or a TTL rising edge appearing on START Input. The two sources of START event can be used together or independently any time (they are in logical OR relation).

You can clear all stored parameters if you press and hold F button down, while BioStim Controller is switched on. During programming actions the equipment checks the validity of the actual value. If you try to accept (with F button) a number out of range, the software will not allow it. If more than one parameters are incoherent, you will be asked to correct them.

UP and DOWN button is used to navigate in menus, and to modify parameter values up or down, respectively. F button is used to select a menu item, or accept a parameter value. Furthermore, F button is used to cancel a function if it is running. If you cancel a function with F button, you will get an access to Function Choice menu. START button is used to start the sequence of pulses, if a 'single' or a 'delayed' function is selected actually. The 'repetitive' functions can be interrupted temporarily with START button (and they can be restarted again with it).